

lionel retail shelves

#7403

LIONEL

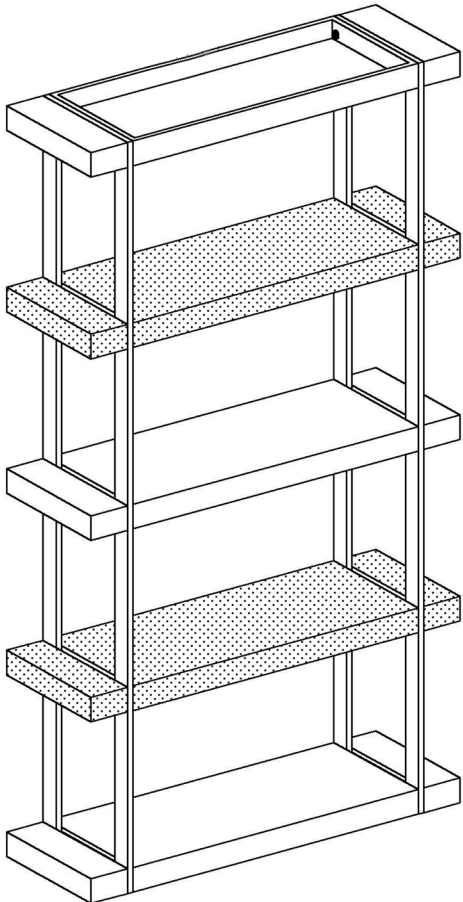



IMPORTANT PLEASE READ THESE SAFETY INSTRUCTIONS

GENERAL SAFETY

1. Read carefully and keep these instructions in a safe place.
2. Use this product only for its intended function and do not use attachments not recommended by the manufacturer.
3. Do not use outdoors.

GET STARTED

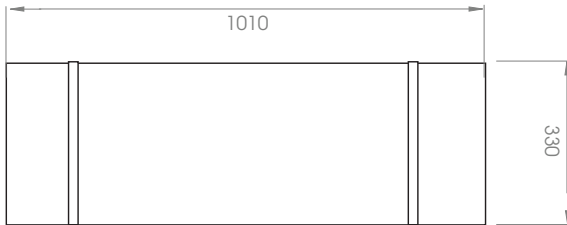

LIONEL

Retail Shelves

Colour: Concrete Look Finish, Gloss White

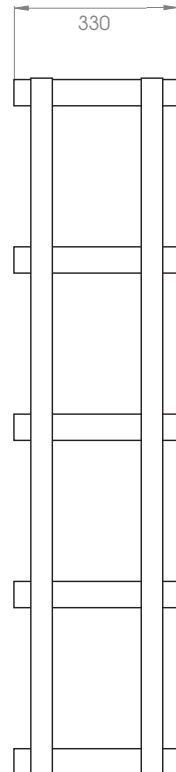
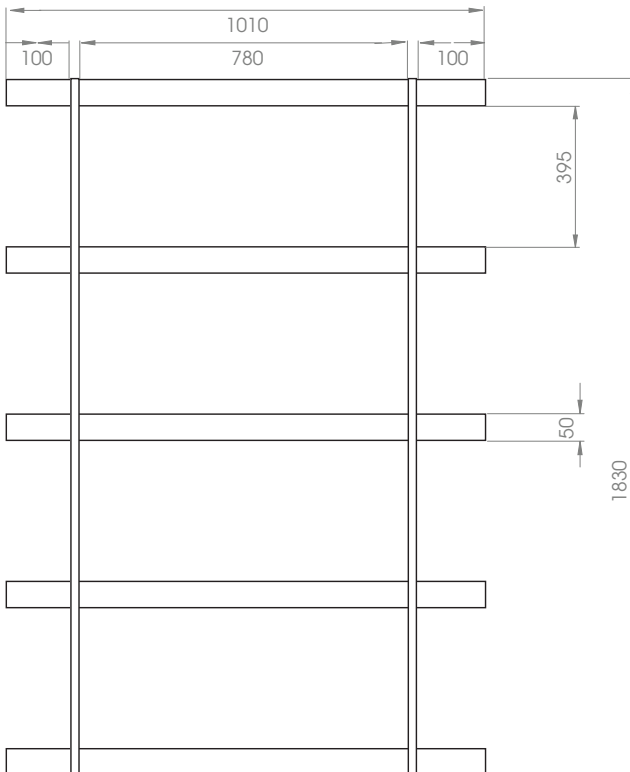





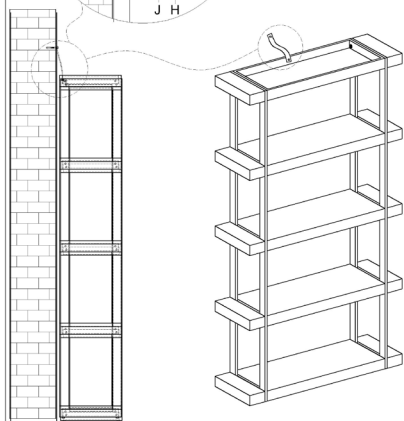
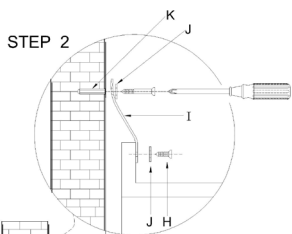
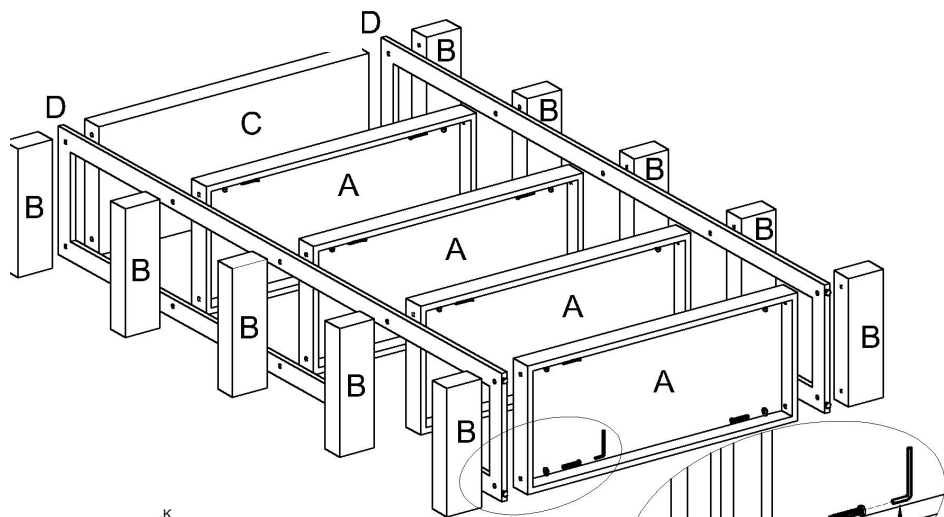









All measurements are in MM.

INSTALLATION & ASSEMBLY



E F G

L	K
	
Ø6*30	Ø6*30
1PC	1PC
I	J
	
150mm	φ6/φ13
1PC	2PCS

A	B	C	D	E	F	G	H	I	J
									
4PCS	10PCS	1PC	2PCS	Ø8/Ø19*2 20PCS	M8*50 20PCS	5mm 1PC	φ4*12 1PC	150mm 1PC	φ6/φ13 2PCS

WARRANTY PERIOD

PERIOD AND DESCRIPTION	PRODUCTS
12 MONTHS PARTS & LABOR	All products
2 YEARS PARTS ONLY	All products excluding small electrical appliances
3 YEARS PARTS ONLY	All Linak electric actuators
5 YEARS PARTS ONLY	Taps cartridge, Ceramic basins

TERMS AND CONDITIONS

For more information about our terms and conditions including warranty, please refer to our website.

CLEANING

GENERAL CLEANING

- We recommend the use of soapy water or approved cleaners.
- This product should not be cleaned with abrasive materials.
- Damage caused by any improper treatment is not covered by the product warranty

MAINTENANCE

A periodic inspection of all components and fasteners should be made to ensure that your Comfortel product is structurally intact and functioning properly.

Damaged and broken parts should be replaced and loose fasteners tightened.

All maintenance to be carried out by a suitably qualified tradesperson.

comfortel

comfortel.com.au

PRODUCT CODE

#7403 LIONEL RETAIL SHELVES

Revision Date: 14.06.2018

©Comfortel Furniture 1997-2018. All rights are reserved.
No part of this document may be photocopied, reproduced or translated to another language without written consent of Comfortel Furniture Pty Ltd.

The information contained in this document is subject to change without notice and should not be construed as a commitment by Comfortel Furniture Pty Ltd.

Comfortel Furniture Pty Ltd. assumes no responsibility for any errors that may appear in this document nor does it make expressed or implied warranty of any kind with regard to this material, including, but not limited to, the implied warranties of merchantability and fitness for a particular purpose.

Comfortel Furniture Pty Ltd. shall not be liable for incidental or consequential damages in connection with or arising out of the use of this document and the program material.

PLEASE RETAIN THIS INFORMATION FOR FUTURE REFERENCE

For more information about our products and services, contact us at comfortel.com.au

PURCHASE DATE

INVOICE NUMBER

NOTE YOUR PURCHASE DATE & INVOICE NUMBER FOR FUTURE REFERENCE